

Lyophilized Bead Forming System

LFD00220-1

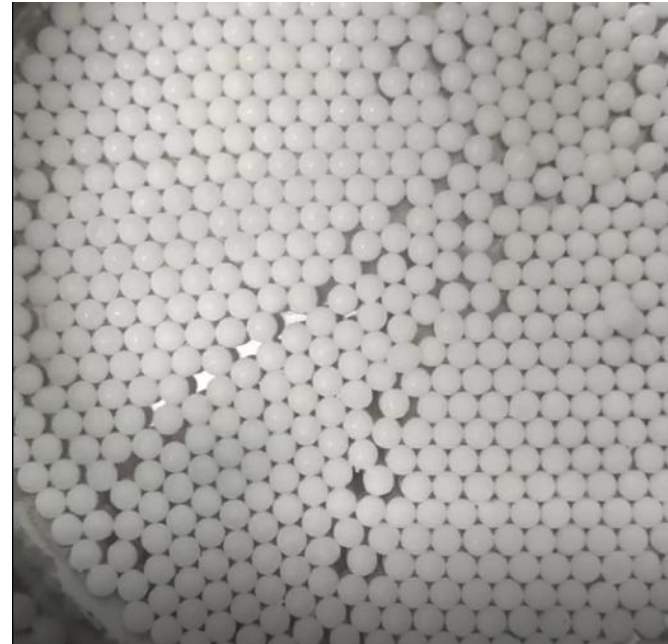

Spec:

1. Bead diameter 1.0mm~4.0mm
2. Dispensing volume 2ul~40ul
3. Automated dispensing liquid
4. Max capacity 9,000 beads/hour

Lyophilized Bead Forming System

LFD00220-1

Overview

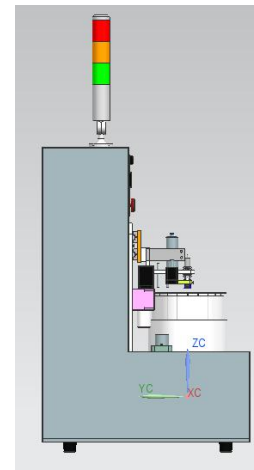
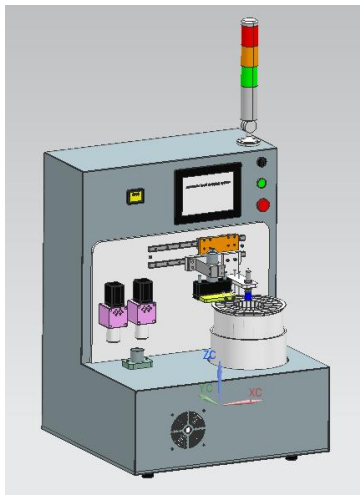
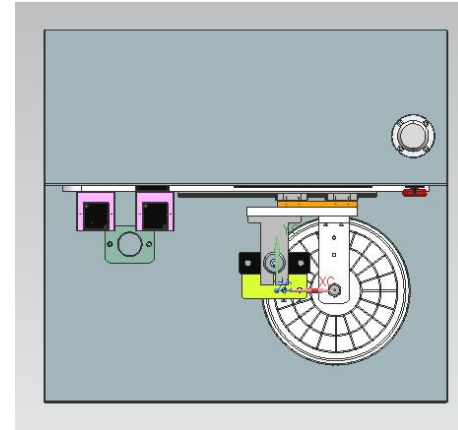
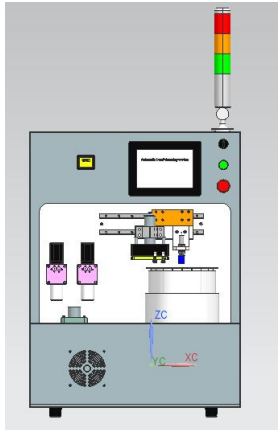

Lyophilized Bead Forming System

LFD00220-1

Dimension

L650 * W650 * H1,000(mm)

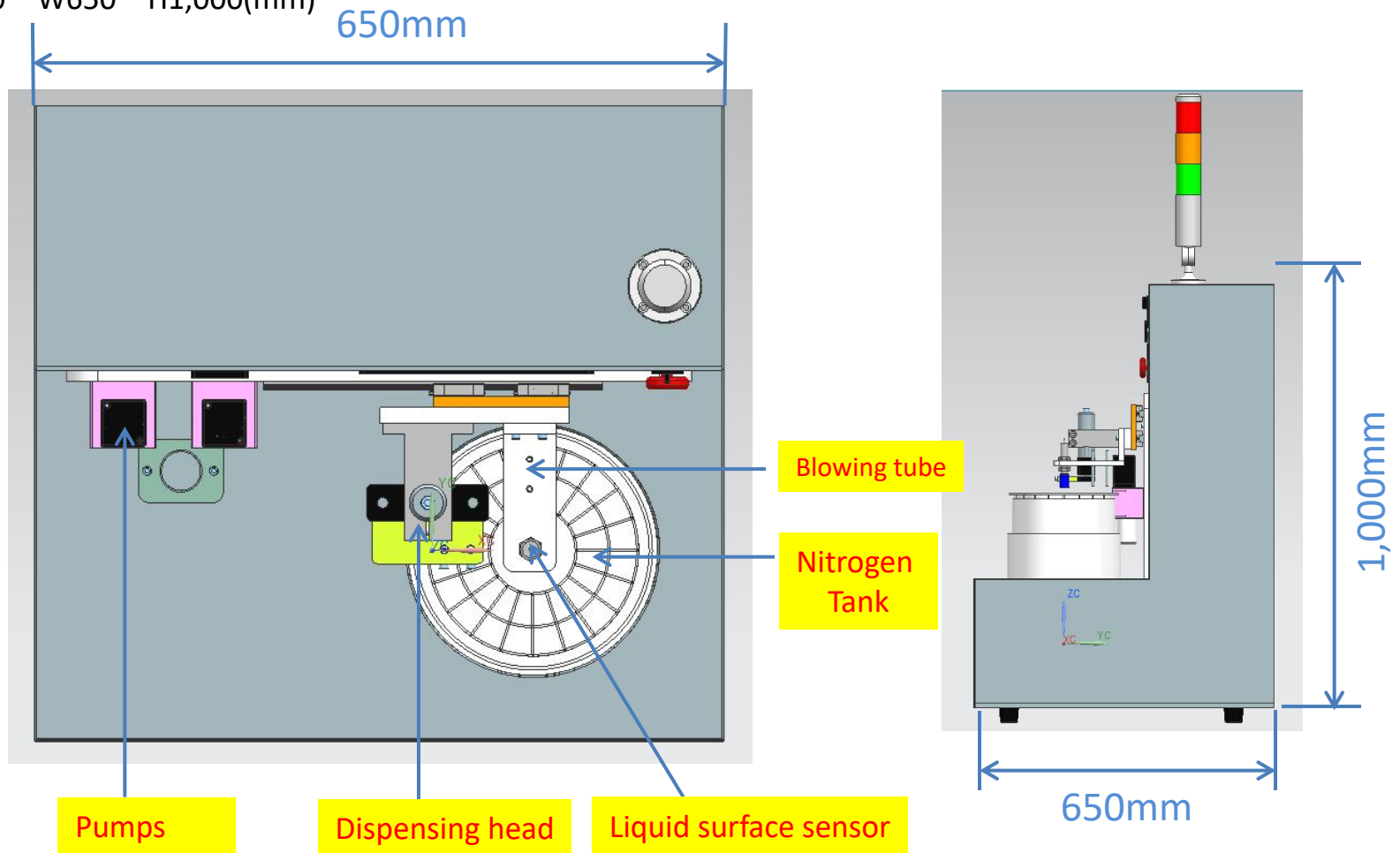

Lyophilized Bead Forming System

LFD00220-1

Workstation

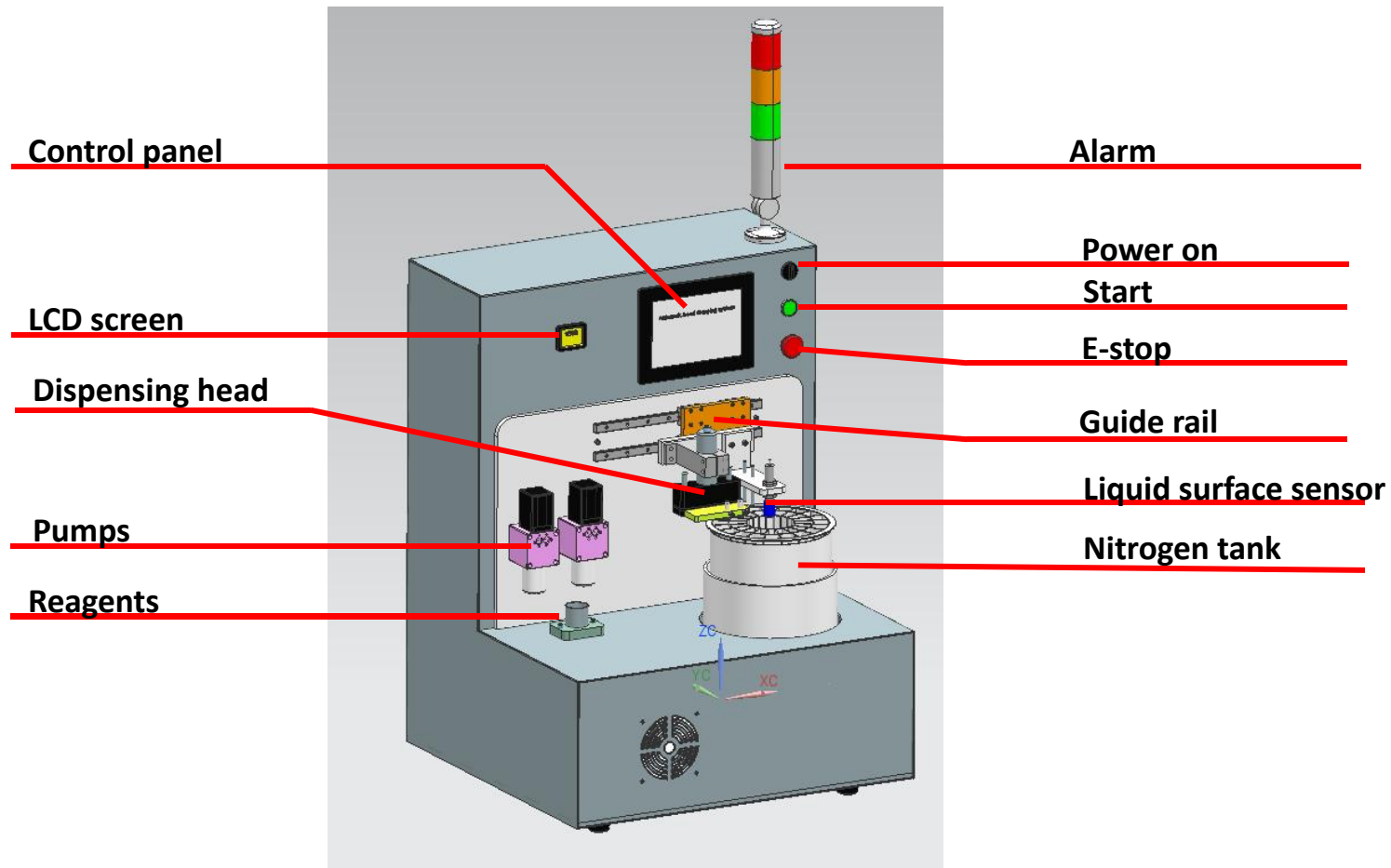

Lyophilized Bead Forming System

LFD00220-1

Features:

1. Touch screen
2. Capacity 9,000 beads/hour
3. Two pumps
4. Liquid nitrogen auto detection
5. Easy to use
6. Easy for maintenance

Operation:

1. Connect with power supply and air supply
2. Prepare liquid nitrogen
3. Prepare reagents liquid
4. Clean tubes
5. Start running

Lyophilized Bead Forming System

LFD00220-1

Parameters	
Capacity	9,000 beads/H
Activation	80%
Liquid nitrogen	Manual feeding
Air supply	0.5~0.8MPa
Power supply	AC220V/50Hz
Internal power supply	DC/24V
Power	1.5KW
Weight	250kg
Dimension	L0.65 * W0.65 * H1.0m
Packing	L1.0 * W1.0 * H1.4(m)

Lyophilized Bead Forming System

LFD00220-1

Key components	
PLC	Mitsubishi/Panasonic
Operation system	ANTITECK
Servo	Inovance/KNK
Relay	Schneider/CHNT
Sensor	OMRON/Panasonic
Cylinder	SMC/AIRTAC
Solenoid valve	SMC/AIRTAC
Connector	SMC/AIRTAC